

Radiation Hardened Dual 36V Precision Single-Supply, Rail-to-Rail Output, Low-Power Operational Amplifiers

ISL70218SEH

The ISL70218SEH is a dual, low-power precision amplifier optimized for single-supply applications. This op amp features a common mode input voltage range extending to 0.5V below the V- rail, a rail-to-rail differential input voltage range, and rail-to-rail output voltage swing, which makes it ideal for single-supply applications where input operation at ground is important.

This op amp features low-power, low-offset voltage, and low-temperature drift, making it ideal for applications requiring both high DC accuracy and AC performance. This amplifier is designed to operate over a single supply range of 3V to 36V or a split supply voltage range of +1.8V/-1.2V to ±18V. The combination of precision and small footprint provides the user with outstanding value and flexibility relative to similar competitive parts.

Applications for this amplifier include precision instrumentation, data acquisition and precision power supply controls.

The ISL70218SEH is available in a 10 lead hermetic ceramic flatpack and operates across the extended temperature range of -55°C to +125°C.

Related Literature

- [AN1653](#), "ISL70218SRH Evaluation Board User's Guide"
- [AN1677](#), "Single Events Effects Testing of the ISL70218SRH, Dual 36V Rad Hard Low Power Operational Amplifiers"

Features

- DLA SMD# [5962-12222](#)
- Wide single and dual supply range 3V to 42V, Abs. Max.
- Low current consumption 850µA, Typ.
- Low input offset voltage. 40µV, Typ.
- Rail-to-rail output <10mV
- Rail-to-rail input differential voltage range for comparator applications
- Operating temperature range. -55°C to +125°C
- Below-ground (V-) input capability to -0.5V
- Low noise voltage. 5.6nV/√Hz, Typ.
- Low noise current. 355fA/√Hz, Typ.
- Offset voltage temperature drift 0.3µV/°C, Typ.
- No phase reversal
- Radiation tolerance
 - High dose rate (50-300rad(Si)/s). 100krad(Si)
 - Low dose rate (0.01rad(Si)/s) 100krad(Si)*
 - SEB LET_{TH} (V_S = ±18V) 86.4 MeV*cm²/mg
 - SEL Immune (SOI Process)

* Product capability established by initial characterization. The EH version is acceptance tested on a wafer-by-wafer basis to 50krad(Si) at low dose rate.

Applications

- Precision instruments
- Active filter blocks
- Data acquisition
- Power supply control

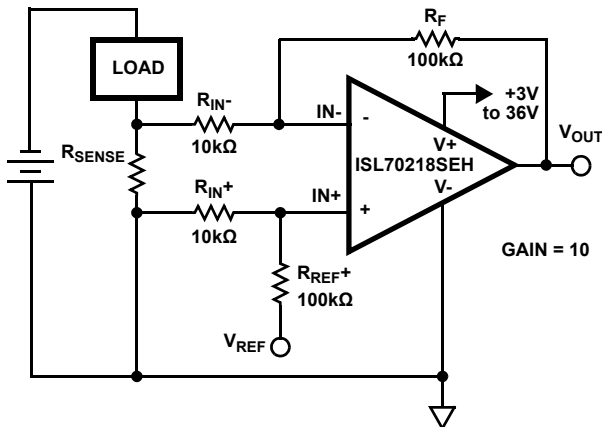

FIGURE 1. TYPICAL APPLICATION: SINGLE-SUPPLY, LOW-SIDE CURRENT SENSE AMPLIFIER

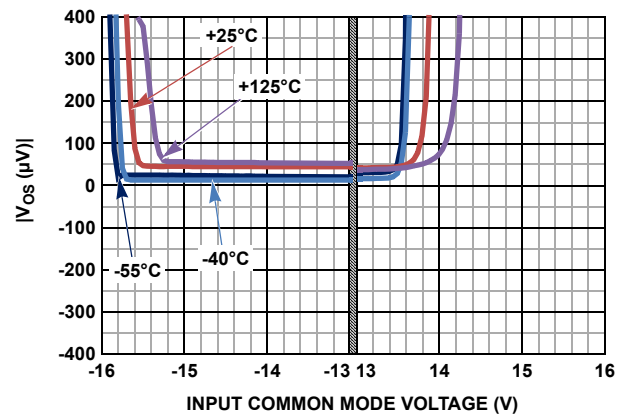
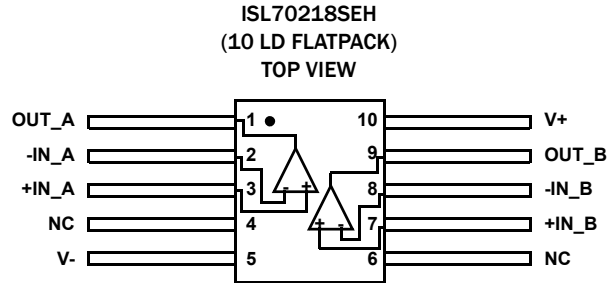

FIGURE 2. INPUT OFFSET VOLTAGE vs INPUT COMMON MODE VOLTAGE, V_S = ±15V

ISL70218SEH

Pin Configuration



Pin Descriptions

| PIN NUMBER | PIN NAME | EQUIVALENT CIRCUIT | DESCRIPTION |
|------------|----------|--------------------|---------------------------------|
| 1 | OUT_A | Circuit 2 | Amplifier A output |
| 2 | -IN_A | Circuit 1 | Amplifier A inverting input |
| 3 | +IN_A | Circuit 1 | Amplifier A non-inverting input |
| 4 | NC | | No connect |
| 5 | V- | Circuit 1, 2, 3 | Negative power supply |
| 6 | NC | | No connect |
| 7 | +IN_B | Circuit 1 | Amplifier B non-inverting input |
| 8 | -IN_B | Circuit 1 | Amplifier B inverting input |
| 9 | OUT_B | Circuit 2 | Amplifier B output |
| 10 | V+ | Circuit 1, 2, 3 | Positive power supply |

CIRCUIT 1

CIRCUIT 2

CIRCUIT 3

Ordering Information

| ORDERING SMD NUMBER (Notes 1, 2) | PART NUMBER | TEMP RANGE (°C) | PACKAGE (RoHS Compliant) | PKG. DWG. # |
|-------------------------------------|----------------------|--------------------|-----------------------------|----------------|
| 5962R1222201VXC | ISL70218SEHVF | -55 to +125 | 10 Ld Flatpack | K10.A |
| ISL70218SEHF/PROTO | ISL70218 SEHF/PROTO | -55 to +125 | 10 Ld Flatpack | K10.A |
| 5962R1222201V9A | ISL70218SEHVX | -55 to +125 | Die | |
| ISL70218SEHX/SAMPLE | ISL70218SEHVX/SAMPLE | -55 to +125 | Die | |
| ISL70218SRHMEVAL1Z | Evaluation Board | | | |

NOTES:

- These Intersil Pb-free Hermetic packaged products employ 100% Au plate - e4 termination finish, which is RoHS compliant and compatible with both SnPb and Pb-free soldering operations.
- Specifications for Rad Hard QML devices are controlled by the Defense Logistics Agency Land and Maritime (DLA). The SMD numbers listed in the "Ordering Information" table must be used when ordering.

ISL70218SEH

Absolute Maximum Ratings

| | |
|---|--|
| Maximum Supply Voltage | 42V |
| Maximum Supply Voltage (LET = 86.4 MeV • cm ² /mg) | 36V |
| Maximum Differential Input Current | 20mA |
| Maximum Differential Input Voltage | V ₋ - 0.5V to V ₊ + 0.5V |
| Min/Max Input Voltage | V ₋ - 0.5V to V ₊ + 0.5V |
| Max/Min Input Current | ±20mA |
| Output Short-Circuit Duration (1 output at a time) | Indefinite |
| ESD Tolerance | |
| Human Body Model (Tested per MIL-PRF-883 3015.7) | 2kV |
| Machine Model (Tested per JESD22-A115-A) | 300V |
| Charged Device Model (Tested per CDM-22C10ID) | 750V |
| Dielectrically Isolated PR40 Process | Latch-up free |

Thermal Information

| | | |
|-------------------------------------|---------------------------|----------------------|
| Thermal Resistance (Typical) | θ_{JA} (°C/W) | θ_{JC} (°C/W) |
| 10 Ld Flatpack Package (Notes 3, 4) | 130 | 20 |
| Storage Temperature Range | -65°C to +150°C | |
| Pb-Free Reflow Profile | see TB493 | |

Recommended Operating Conditions

| | |
|--|--------------------------------|
| Ambient Operating Temperature Range | -55°C to +125°C |
| Maximum Operating Junction Temperature | +150°C |
| Supply Voltage | 3V (+1.8V/-1.2V) to 30V (±15V) |

CAUTION: Do not operate at or near the maximum ratings listed for extended periods of time. Exposure to such conditions may adversely impact product reliability and result in failures not covered by warranty.

NOTES:

- θ_{JA} is measured with the component mounted on a low effective thermal conductivity test board in free air. See Tech Brief [TB379](#) for details.
- For θ_{JC} , the "case temp" location is the center of the package underside.

Electrical Specifications $V_S \pm 15V$, $V_{CM} = 0$, $V_O = 0V$, $R_L = \text{Open}$, $T_A = +25^\circ\text{C}$, unless otherwise noted. **Boldface limits apply across the operating temperature range, -55°C to +125°C.**

| PARAMETER | DESCRIPTION | CONDITIONS | MIN (Note 5) | TYP | MAX (Note 5) | UNIT |
|-----------------|---|---|-----------------|------|-------------------|------------------------------|
| V_{OS} | Offset Voltage | | | 40 | 230 | μV |
| | | | | | 290 | μV |
| TCV_{OS} | Offset Voltage Drift | | | 0.3 | 1.4 | $\mu\text{V}/^\circ\text{C}$ |
| ΔV_{OS} | Input Offset Voltage Match Channel to Channel | | | 44 | 280 | μV |
| | | | | | 365 | μV |
| I_{OS} | Input Offset Current | | -50 | 4 | 50 | nA |
| | | | -75 | | 75 | nA |
| I_B | Input Bias Current | | -575 | -230 | | nA |
| | | | -800 | | | nA |
| V_{CMIR} | Common Mode Input Voltage Range | Guaranteed by CMRR Test | (V-) - 0.5 | | (V+) - 1.8 | V |
| | | | V- | | (V+) - 1.8 | V |
| CMRR | Common Mode Rejection Ratio | $V_{CM} = V_-$ to $V_+ - 1.8V$ | 100 | 118 | | dB |
| | | $V_{CM} = V_-$ to $V_+ - 1.8V$ | 97 | | | dB |
| PSRR | Power Supply Rejection Ratio | $V_S = 3V$ to 40V, $V_{CMIR} = \text{Valid Input Voltage}$ | 105 | 124 | | dB |
| | | | 100 | | | dB |
| A_{VOL} | Open-Loop Gain | $R_L = 10k\Omega$ to ground $V_O = -13V$ to +13V | 120 | 130 | | dB |
| | | | 115 | | | dB |
| V_{OH} | Output Voltage High, V_+ to V_{OUT} | $R_L = 10k\Omega$ | | | 110 | mV |
| | | | | | 120 | mV |
| V_{OL} | Output Voltage Low, V_{OUT} to V_- | $R_L = 10k\Omega$ | | | 70 | mV |
| | | | | | 80 | mV |
| I_S | Supply Current/Amplifier | | | 0.85 | 1.1 | mA |
| | | | | | 1.4 | mA |
| I_{S+} | Source Current Capability | | 10 | | | mA |
| I_{S-} | Sink Current Capability | | 10 | | | mA |
| V_{SUPPLY} | Supply Voltage Range | Guaranteed by PSRR | 3 | | 40 | V |

ISL70218SEH

Electrical Specifications $V_S \pm 15V$, $V_{CM} = 0$, $V_O = 0V$, $R_L = \text{Open}$, $T_A = +25^\circ\text{C}$, unless otherwise noted. **Boldface limits apply across the operating temperature range, -55°C to $+125^\circ\text{C}$.** (Continued)

| PARAMETER | DESCRIPTION | CONDITIONS | MIN (Note 5) | TYP | MAX (Note 5) | UNIT |
|------------------------------|--|---|-----------------------------|-----------|-----------------|------------------------|
| AC SPECIFICATIONS | | | | | | |
| GBW | Gain Bandwidth Product | $A_{CL} = 101$, $V_{OUT} = 100mV_{P-P}$; $R_L = 2k$ | | 4 | | MHz |
| e_{n-p-p} | Voltage Noise | 0.1Hz to 10Hz, $V_S = \pm 18V$ | | 300 | | nV _{P-P} |
| e_n | Voltage Noise Density | $f = 10\text{Hz}$, $V_S = \pm 18V$ | | 8.5 | | nV/ $\sqrt{\text{Hz}}$ |
| e_n | Voltage Noise Density | $f = 100\text{Hz}$, $V_S = \pm 18V$ | | 5.8 | | nV/ $\sqrt{\text{Hz}}$ |
| e_n | Voltage Noise Density | $f = 1\text{kHz}$, $V_S = \pm 18V$ | | 5.6 | | nV/ $\sqrt{\text{Hz}}$ |
| e_n | Voltage Noise Density | $f = 10\text{kHz}$, $V_S = \pm 18V$ | | 5.6 | | nV/ $\sqrt{\text{Hz}}$ |
| i_n | Current Noise Density | $f = 1\text{kHz}$, $V_S = \pm 18V$ | | 355 | | fA/ $\sqrt{\text{Hz}}$ |
| THD + N | Total Harmonic Distortion + Noise | 1kHz, $G = 1$, $V_O = 3.5V_{RMS}$, $R_L = 10k\Omega$ | | 0.0003 | | % |
| TRANSIENT RESPONSE | | | | | | |
| SR | Slew Rate | $A_V = 1$, $R_L = 2k\Omega$, $V_O = 10V_{P-P}$ | ± 1.0 | ± 1.2 | | V/ μs |
| | | | ± 0.4 | | | V/ μs |
| t_r , t_f , Small Signal | Rise Time 10% to 90% of V_{OUT} | $A_V = 1$, $V_{OUT} = 100mV_{P-P}$, $R_f = 0\Omega$, $R_L = 2k\Omega$ to V_{CM} | | 100 | 200 | ns |
| | | | | | 400 | ns |
| | Fall Time 90% to 10% of V_{OUT} | $A_V = 1$, $V_{OUT} = 100mV_{P-P}$, $R_f = 0\Omega$, $R_L = 2k\Omega$ to V_{CM} | | 100 | 230 | ns |
| | | | | | 400 | ns |
| t_s | Settling Time to 0.01% 10V Step; 10% to V_{OUT} | $A_V = 1$, $V_{OUT} = 10V_{P-P}$, $R_f = 0\Omega$, $R_L = 2k\Omega$ to V_{CM} | | 8.5 | | μs |
| OS+ | Positive Overshoot | $A_V = 1$, $V_{OUT} = 10V_{P-P}$, $R_f = 0\Omega$, $R_L = 2k\Omega$ to V_{CM} | | 5 | | % |
| | | | | | 35 | % |
| OS- | Negative Overshoot | $A_V = 1$, $V_{OUT} = 10V_{P-P}$, $R_f = 0\Omega$, $R_L = 2k\Omega$ to V_{CM} | | 5 | | % |
| | | | | | 35 | % |

Electrical Specifications $V_S \pm 15V$, $V_{CM} = 0$, $V_O = 0V$, $R_L = \text{Open}$, $T_A = +25^\circ\text{C}$, unless otherwise noted. **Boldface limits apply over a total ionizing dose of 100krad(Si) with exposure at a high dose rate of 50 - 300krad(Si)/s; and over a total ionizing dose of 50krad(Si) with exposure at a low dose rate of <10mrads(Si)/s.**

| PARAMETER | DESCRIPTION | CONDITIONS | MIN (Note 5) | TYP | MAX (Note 5) | UNIT |
|-------------------|---|--------------------------------|-----------------|------|-------------------|------------------------------|
| V_{OS} | Offset Voltage | | | 40 | 230 | μV |
| | | | | | 290 | μV |
| TCV _{OS} | Offset Voltage Drift | | | 0.3 | 1.4 | $\mu\text{V}/^\circ\text{C}$ |
| ΔV_{OS} | Input Offset Voltage Match Channel to Channel | | | 44 | 280 | μV |
| | | | | | 365 | μV |
| I_{OS} | Input Offset Current | | -50 | 4 | 50 | nA |
| | | | -75 | | 75 | nA |
| I_B | Input Bias Current | | -575 | -230 | | nA |
| | | | -1500 | | | nA |
| V_{CMIR} | Common Mode Input Voltage Range | Guaranteed by CMRR Test | (V-) - 0.5 | | (V+) - 1.8 | V |
| | | | V- | | (V+) - 1.8 | V |
| CMRR | Common Mode Rejection Ratio | $V_{CM} = V_-$ to $V_+ - 1.8V$ | 100 | 118 | | dB |
| | | $V_{CM} = V_-$ to $V_+ - 1.8V$ | 97 | | | dB |

ISL70218SEH

Electrical Specifications $V_S \pm 15V$, $V_{CM} = 0$, $V_O = 0V$, $R_L = \text{Open}$, $T_A = +25^\circ C$, unless otherwise noted. **Boldface limits apply over a total ionizing dose of 100krad(Si) with exposure at a high dose rate of 50 - 300krad(Si)/s; and over a total ionizing dose of 50krad(Si) with exposure at a low dose rate of <10mrads(Si)/s. (Continued)**

| PARAMETER | DESCRIPTION | CONDITIONS | MIN (Note 5) | TYP | MAX (Note 5) | UNIT |
|------------------------------|--|--|-----------------------------|-----------|-----------------|-------------------|
| PSRR | Power Supply Rejection Ratio | $V_S = 3V \text{ to } 40V$, $V_{CMIR} = \text{Valid Input Voltage}$ | 105 | 124 | | dB |
| | | | 100 | | | dB |
| A_{VOL} | Open-Loop Gain | $R_L = 10k\Omega \text{ to ground}$ $V_O = -13V \text{ to } +13V$ | 120 | 130 | | dB |
| | | | 115 | | | dB |
| V_{OH} | Output Voltage High, V_+ to V_{OUT} | $R_L = 10k\Omega$ | | | 110 | mV |
| | | | | | 120 | mV |
| V_{OL} | Output Voltage Low, V_{OUT} to V_- | $R_L = 10k\Omega$ | | | 70 | mV |
| | | | | | 80 | mV |
| I_S | Supply Current/Amplifier | | | 0.85 | 1.1 | mA |
| | | | | | 1.4 | mA |
| I_{S+} | Source Current Capability | | 10 | | | mA |
| I_{S-} | Sink Current Capability | | 10 | | | mA |
| V_{SUPPLY} | Supply Voltage Range | Guaranteed by PSRR | 3 | | 40 | V |
| AC SPECIFICATIONS | | | | | | |
| GBW | Gain Bandwidth Product | $A_{CL} = 101$, $V_{OUT} = 100mV_{P-P}$; $R_L = 2k\Omega$ | | 4 | | MHz |
| e_{n-p-p} | Voltage Noise | 0.1Hz to 10Hz, $V_S = \pm 18V$ | | 300 | | nV _{P-P} |
| e_n | Voltage Noise Density | $f = 10Hz$, $V_S = \pm 18V$ | | 8.5 | | nV/ \sqrt{Hz} |
| e_n | Voltage Noise Density | $f = 100Hz$, $V_S = \pm 18V$ | | 5.8 | | nV/ \sqrt{Hz} |
| e_n | Voltage Noise Density | $f = 1kHz$, $V_S = \pm 18V$ | | 5.6 | | nV/ \sqrt{Hz} |
| e_n | Voltage Noise Density | $f = 10kHz$, $V_S = \pm 18V$ | | 5.6 | | nV/ \sqrt{Hz} |
| i_n | Current Noise Density | $f = 1kHz$, $V_S = \pm 18V$ | | 355 | | fA/ \sqrt{Hz} |
| THD + N | Total Harmonic Distortion + Noise | 1kHz, $G = 1$, $V_O = 3.5V_{RMS}$, $R_L = 10k\Omega$ | | 0.0003 | | % |
| TRANSIENT RESPONSE | | | | | | |
| SR | Slew Rate | $A_V = 1$, $R_L = 2k\Omega$, $V_O = 10V_{P-P}$ | ± 1.0 | ± 1.2 | | V/ μs |
| | | | ± 0.4 | | | V/ μs |
| t_r , t_f , Small Signal | Rise Time 10% to 90% of V_{OUT} | $A_V = 1$, $V_{OUT} = 100mV_{P-P}$, $R_f = 0\Omega$, $R_L = 2k\Omega \text{ to } V_{CM}$ | | 100 | 230 | ns |
| | Fall Time 90% to 10% of V_{OUT} | $A_V = 1$, $V_{OUT} = 100mV_{P-P}$, $R_f = 0\Omega$, $R_L = 2k\Omega \text{ to } V_{CM}$ | | 100 | 200 | ns |
| t_s | Settling Time to 0.01% 10V Step; 10% to V_{OUT} | $A_V = 1$, $V_{OUT} = 10V_{P-P}$, $R_f = 0\Omega$, $R_L = 2k\Omega \text{ to } V_{CM}$ | | 8.5 | | μs |
| | | | | | | |
| OS+ | Positive Overshoot | $A_V = 1$, $V_{OUT} = 10V_{P-P}$, $R_f = 0\Omega$, $R_L = 2k\Omega \text{ to } V_{CM}$ | | 5 | | % |
| | | | | | 35 | % |
| OS- | Negative Overshoot | $A_V = 1$, $V_{OUT} = 10V_{P-P}$, $R_f = 0\Omega$, $R_L = 2k\Omega \text{ to } V_{CM}$ | | 5 | | % |
| | | | | | 35 | % |

ISL70218SEH

Electrical Specifications $V_S \pm 5V$, $V_{CM} = 0$, $V_O = 0V$, $T_A = +25^\circ C$, unless otherwise noted. **Boldface limits apply over the operating temperature range, $-55^\circ C$ to $+125^\circ C$.**

| PARAMETER | DESCRIPTION | CONDITIONS | MIN (Note 5) | TYP | MAX (Note 5) | UNIT |
|---------------------------|---|---|-----------------|---------|-------------------|-------------------|
| V_{OS} | Offset Voltage | | | 40 | | μV |
| ΔV_{OS} | Input Offset Voltage Match Channel to Channel | | | 44 | | μV |
| I_{OS} | Input Offset Current | | | 4 | | nA |
| I_B | Input Bias Current | | | -230 | | nA |
| V_{CMIR} | Common Mode Input Voltage Range | Guaranteed by CMRR Test | (V-) - 0.5 | | (V+) - 1.8 | V |
| | | | V- | | (V+) - 1.8 | V |
| CMRR | Common-Mode Rejection Ratio | $V_{CM} = V_- - 0.5V$ to $V_+ - 1.8V$ $V_{CM} = V_-$ to $V_+ - 1.8V$ | | 117 | | dB |
| PSRR | Power Supply Rejection Ratio | $V_S = 3V$ to $40V$, $V_{CMIR} =$ Valid Input Voltage | | 124 | | dB |
| A_{VOL} | Open-Loop Gain | $R_L = 10k\Omega$ to ground $V_O = -3V$ to $+3V$ | | 130 | | dB |
| V_{OH} | Output Voltage High, V_+ to V_{OUT} | $R_L = 10k\Omega$ | | 65 | | mV |
| | | | | 70 | | mV |
| V_{OL} | Output Voltage Low, V_{OUT} to V_- | $R_L = 10k\Omega$ | | 38 | | mV |
| | | | | 45 | | mV |
| I_S | Supply Current/Amplifier | | | 0.85 | | mA |
| I_{S+} | Source Current Capability | | | 8 | | mA |
| I_{S-} | Sink Current Capability | | | 8 | | mA |
| AC SPECIFICATIONS | | | | | | |
| GBW | Gain Bandwidth Product | | | 3.2 | | MHz |
| e_{np-p} | Voltage Noise | 0.1Hz to 10Hz | | 320 | | nV _{P-P} |
| e_n | Voltage Noise Density | $f = 10Hz$ | | 9 | | nV/ \sqrt{Hz} |
| e_n | Voltage Noise Density | $f = 100Hz$ | | 5.7 | | nV/ \sqrt{Hz} |
| e_n | Voltage Noise Density | $f = 1kHz$ | | 5.5 | | nV/ \sqrt{Hz} |
| e_n | Voltage Noise Density | $f = 10kHz$ | | 5.5 | | nV/ \sqrt{Hz} |
| i_n | Current Noise Density | $f = 1kHz$ | | 380 | | fA/ \sqrt{Hz} |
| THD + N | Total Harmonic Distortion + Noise | 1kHz, $G = 1$, $V_O = 1.25V_{RMS}$, $R_L = 10k\Omega$ | | 0.0003 | | % |
| TRANSIENT RESPONSE | | | | | | |
| SR | Slew Rate | $A_V = 1$, $R_L = 2k\Omega$, $V_O = 4V_{P-P}$ | | ± 1 | | V/ μs |
| t_r, t_f , Small Signal | Rise Time 10% to 90% of V_{OUT} | $A_V = 1$, $V_{OUT} = 100mV_{P-P}$, $R_f = 0\Omega$, $R_L = 2k\Omega$ to V_{CM} | | 100 | | ns |
| | Fall Time 90% to 10% of V_{OUT} | $A_V = 1$, $V_{OUT} = 100mV_{P-P}$, $R_f = 0\Omega$, $R_L = 2k\Omega$ to V_{CM} | | 100 | | ns |
| t_s | Settling Time to 0.01% 4V Step; 10% to V_{OUT} | $A_V = 1$, $V_{OUT} = 4V_{P-P}$, $R_f = 0\Omega$ $R_L = 2k\Omega$ to V_{CM} | | 4 | | μs |
| OS+ | Positive Overshoot | $A_V = 1$, $V_{OUT} = 10V_{P-P}$, $R_f = 0\Omega$ $R_L = 2k\Omega$ to V_{CM} | | 5 | | % |
| OS- | Negative Overshoot | $A_V = 1$, $V_{OUT} = 10V_{P-P}$, $R_f = 0\Omega$ $R_L = 2k\Omega$ to V_{CM} | | 5 | | % |

NOTE:

5. Compliance to datasheet limits is assured by one or more methods: production test, characterization and/or design.

ISL70218SEH

High Dose Rate Post Radiation Characteristics $V_S \pm 15V$, $V_{CM} = 0V$, $V_O = 0V$, $R_L = \text{Open}$, $T_A = +25^\circ\text{C}$, unless otherwise noted. This data is typical test data post radiation exposure at a rate of 50 to 300rad(Si)/s. This data is intended to show typical parameter shifts due to high dose rate radiation. These are not limits nor are they guaranteed.

| PARAMETER | DESCRIPTION | CONDITIONS | 50k RAD | 75k RAD | 100k RAD | UNIT |
|---------------------------|---|--|---------|---------|----------|------------------------|
| V_{OS} | Offset Voltage | | 35 | 35 | 35 | μV |
| I_{OS} | Input Offset Current | | 2 | 3 | 5 | nA |
| I_B | Input Bias Current | | 200 | 400 | 575 | nA |
| CMRR | Common Mode Rejection Ratio | $V_{CM} = -13V \text{ to } +13V$ | 129 | 128 | 127 | dB |
| PSRR | Power Supply Rejection Ratio | $V_S = \pm 2.25V \text{ to } \pm 15V$ | 130 | 130 | 130 | dB |
| A_{VOL} | Open-Loop Gain | $V_O = -13V \text{ to } +13V$ $R_L = 10k\Omega \text{ to ground}$ | 131.6 | 131.1 | 131.1 | dB |
| V_{OH} | Output Voltage High V_+ to V_{OUT} | $R_L = 10k\Omega \text{ to ground}$ | 71 | 74 | 76 | mV |
| V_{OL} | Output Voltage Low V_{OUT} to V_- | $R_L = 10k\Omega \text{ to ground}$ | 54 | 57 | 59 | mV |
| I_S | Supply Current/Amplifier | | 830 | 830 | 830 | μA |
| TRANSIENT RESPONSE | | | | | | |
| SR | Slew Rate | $A_V = 10$, $R_L = 2k\Omega$, $V_O = 4V_{P-P}$ | 1.24 | 1.23 | 1.22 | $\text{V}/\mu\text{s}$ |

Low Dose Rate Post Radiation Characteristics $V_S \pm 15V$, $V_{CM} = 0V$, $V_O = 0V$, $R_L = \text{Open}$, $T_A = +25^\circ\text{C}$, unless otherwise noted. This data is typical test data post radiation exposure at a rate of 10mrad(Si)/s. This data is intended to show typical parameter shifts due to low dose rate radiation. These are not limits nor are they guaranteed.

| PARAMETER | DESCRIPTION | CONDITIONS | 10k RAD | 20k RAD | 50k RAD | UNIT |
|-----------|--------------------------|------------|---------|---------|---------|---------------|
| V_{OS} | Offset Voltage | | 20 | 20 | 20 | μV |
| I_{OS} | Input Offset Current | | 6 | 8 | 10 | nA |
| I_B | Input Bias Current | | 300 | 500 | 1200 | nA |
| I_S | Supply Current/Amplifier | | 650 | 625 | 615 | μA |

Typical Performance Curves $V_S = \pm 15V, V_{CM} = 0V, R_L = \text{Open}, T_A = +25^\circ\text{C}$, unless otherwise specified.

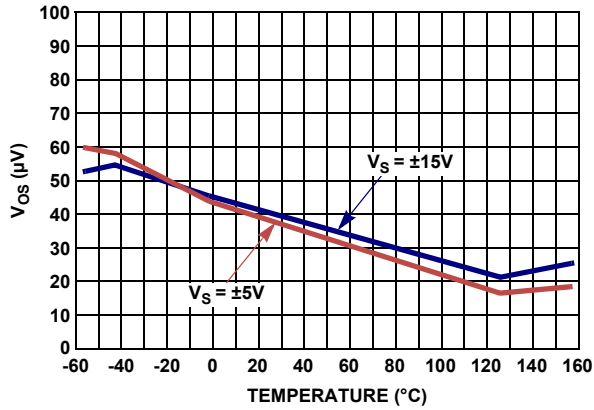

FIGURE 3. V_{OS} vs TEMPERATURE

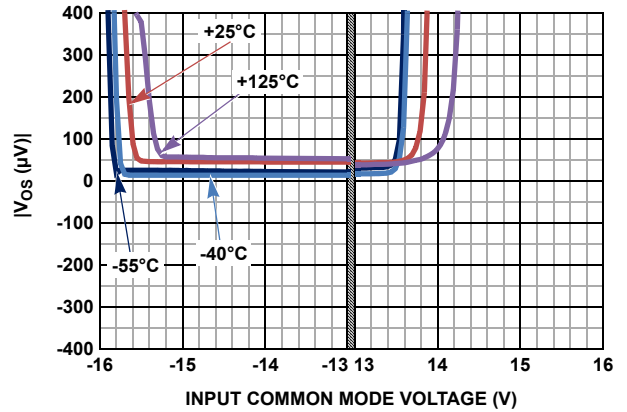

FIGURE 4. INPUT OFFSET VOLTAGE vs INPUT COMMON MODE VOLTAGE, $V_S = \pm 15V$

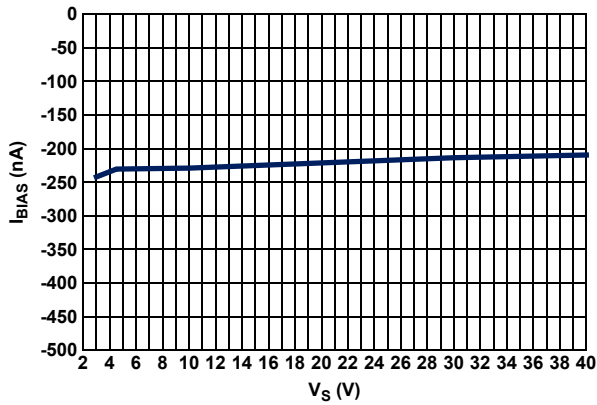

FIGURE 5. I_{BIAS} vs V_S

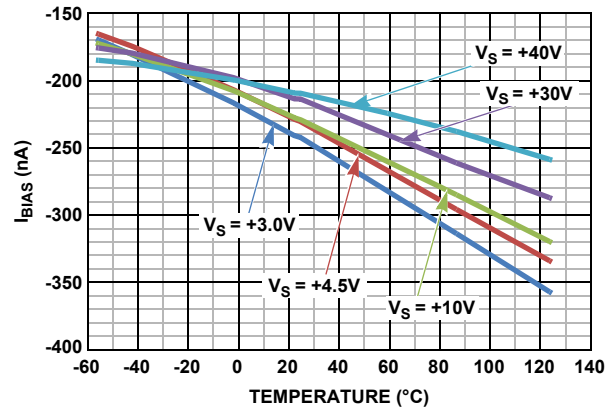

FIGURE 6. I_{BIAS} vs TEMPERATURE vs SUPPLY

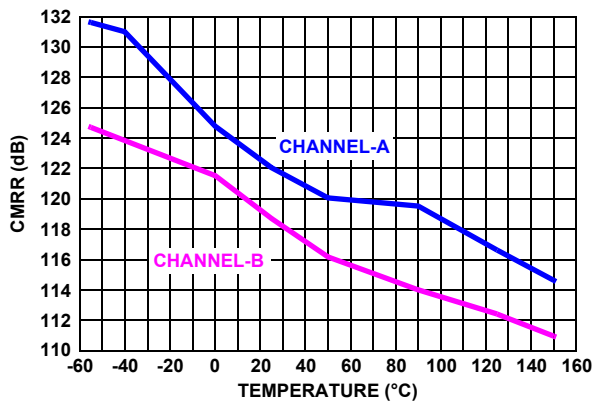

FIGURE 7. CMRR vs TEMPERATURE, $V_S = \pm 15V$

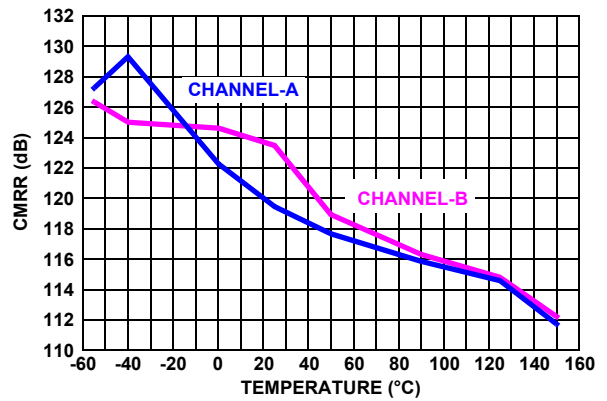

FIGURE 8. CMRR vs TEMPERATURE, $V_S = \pm 5V$

Typical Performance Curves $V_S = \pm 15V, V_{CM} = 0V, R_L = \text{Open}, T_A = +25^\circ C$, unless otherwise specified. (Continued)

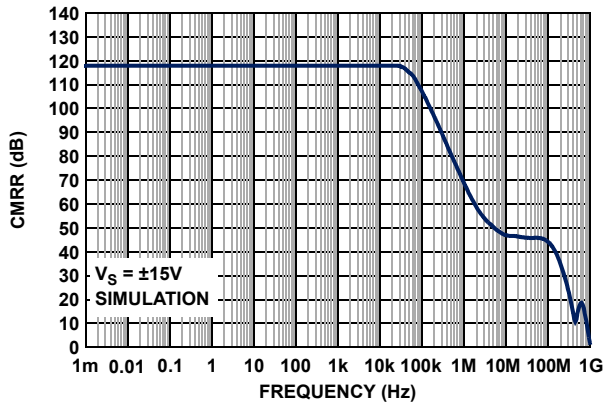

FIGURE 9. CMRR vs FREQUENCY, $V_S = \pm 15V$

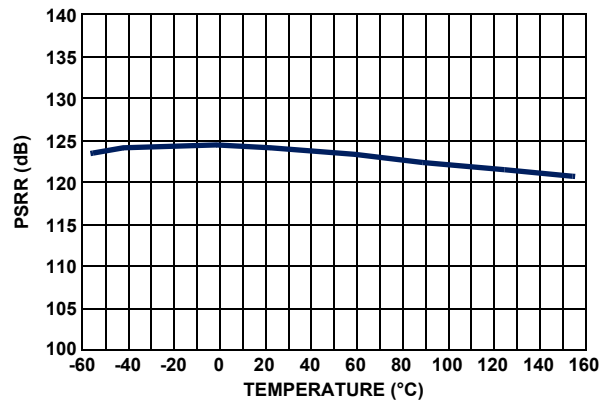

FIGURE 10. PSRR vs TEMPERATURE, $V_S = \pm 15V$

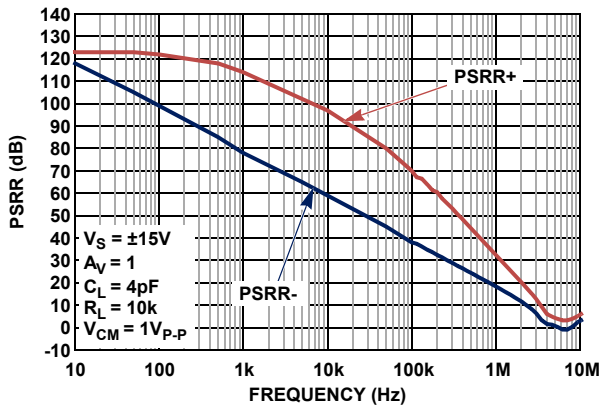

FIGURE 11. PSRR vs FREQUENCY, $V_S = \pm 15V$

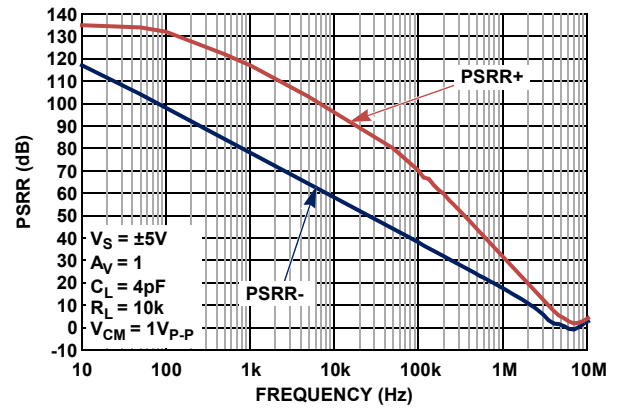

FIGURE 12. PSRR vs FREQUENCY, $V_S = \pm 5V$

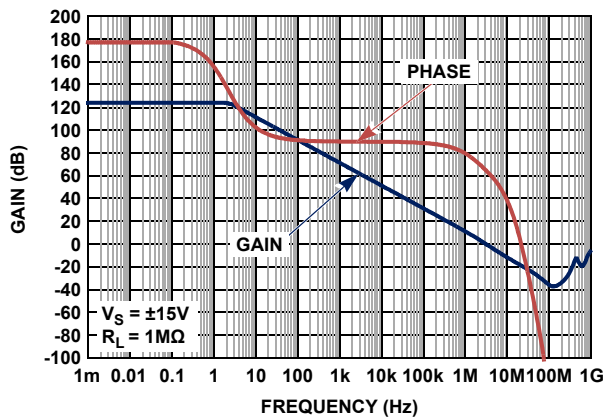

FIGURE 13. OPEN-LOOP GAIN, PHASE vs FREQUENCY, $V_S = \pm 15V$

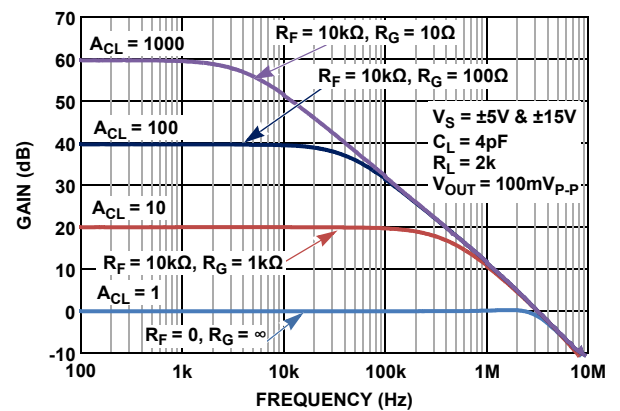

FIGURE 14. FREQUENCY RESPONSE vs CLOSED LOOP GAIN

Typical Performance Curves $V_S = \pm 15V, V_{CM} = 0V, R_L = \text{Open}, T_A = +25^\circ C$, unless otherwise specified. (Continued)

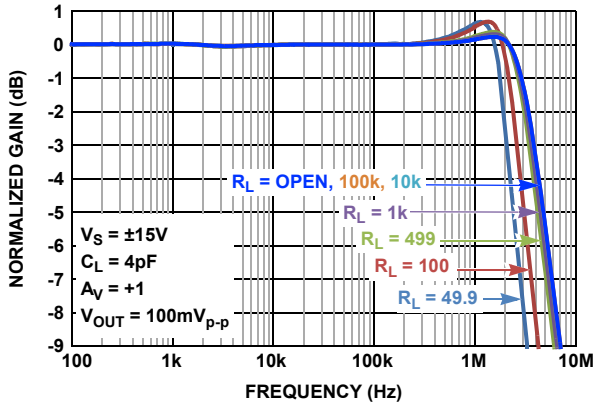

FIGURE 15. GAIN vs FREQUENCY vs $R_L, V_S = \pm 15V$

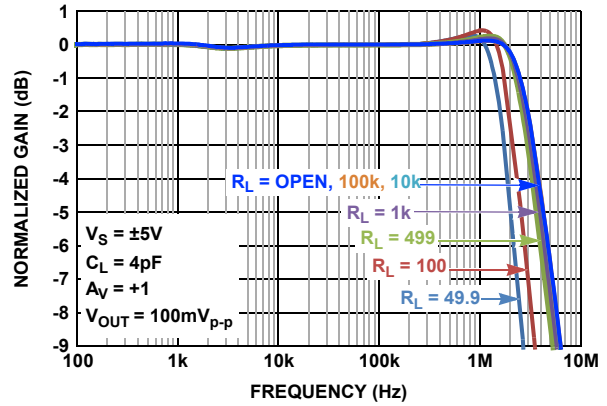

FIGURE 16. GAIN vs FREQUENCY vs $R_L, V_S = \pm 5V$

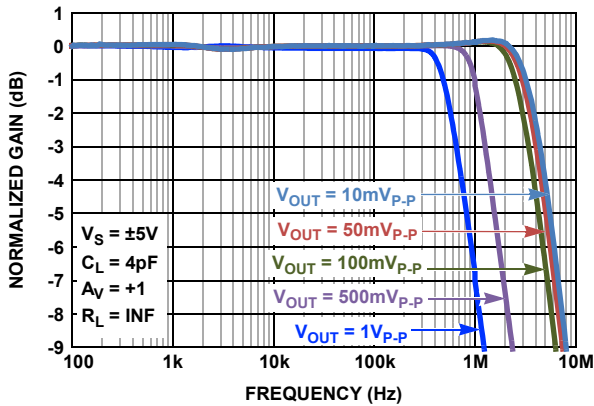

FIGURE 17. GAIN vs FREQUENCY vs OUTPUT VOLTAGE

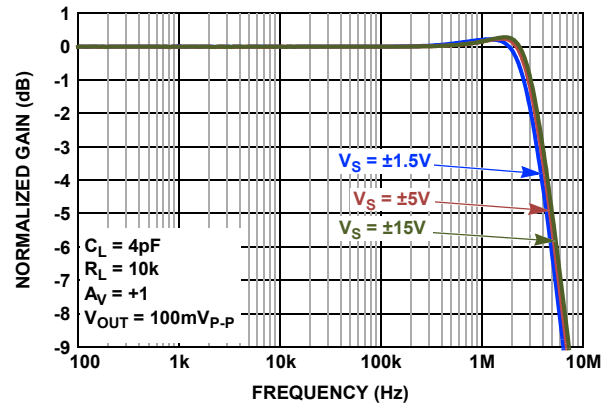

FIGURE 18. GAIN vs FREQUENCY vs SUPPLY VOLTAGE

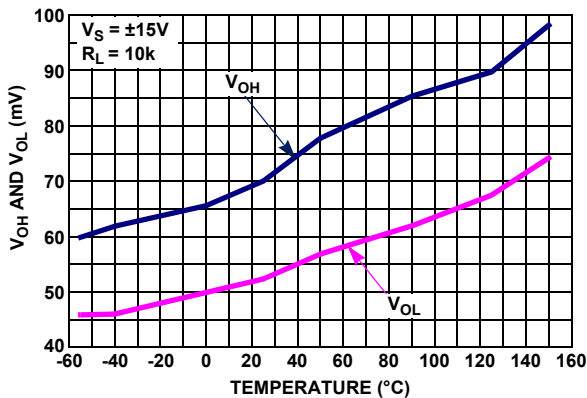

FIGURE 19. OUTPUT OVERHEAD VOLTAGE vs TEMPERATURE, $V_S = \pm 15V, R_L = 10k$

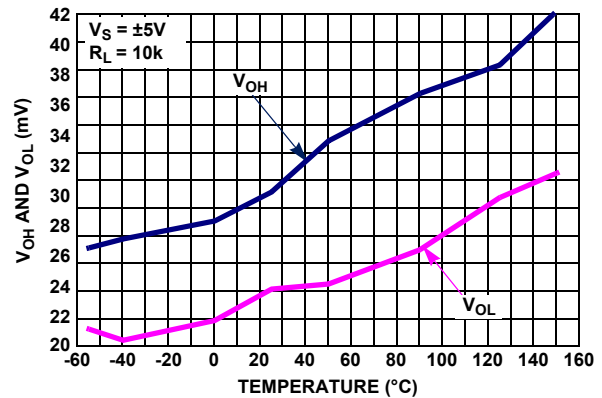

FIGURE 20. OUTPUT OVERHEAD VOLTAGE vs TEMPERATURE, $V_S = \pm 5V, R_L = 10k$

Typical Performance Curves $V_S = \pm 15V, V_{CM} = 0V, R_L = \text{Open}, T_A = +25^\circ C$, unless otherwise specified. (Continued)

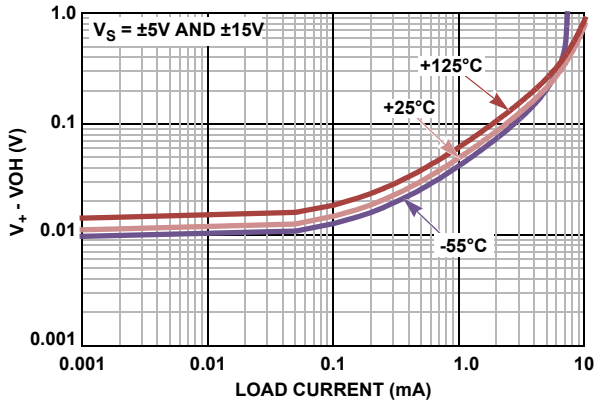

FIGURE 21. OUTPUT OVERHEAD VOLTAGE HIGH vs LOAD CURRENT, $V_S = \pm 5V$ AND $\pm 15V$

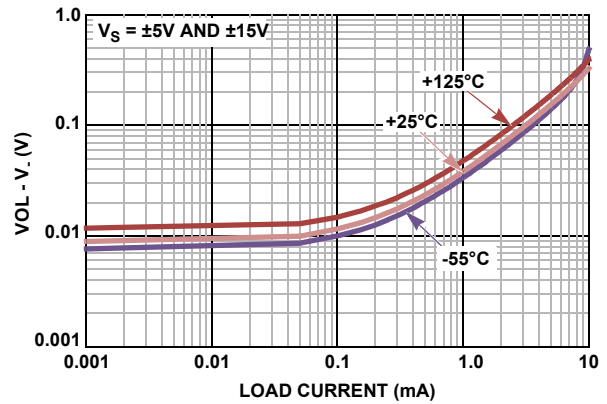

FIGURE 22. OUTPUT OVERHEAD VOLTAGE LOW vs LOAD CURRENT, $V_S = \pm 5V$ AND $\pm 15V$

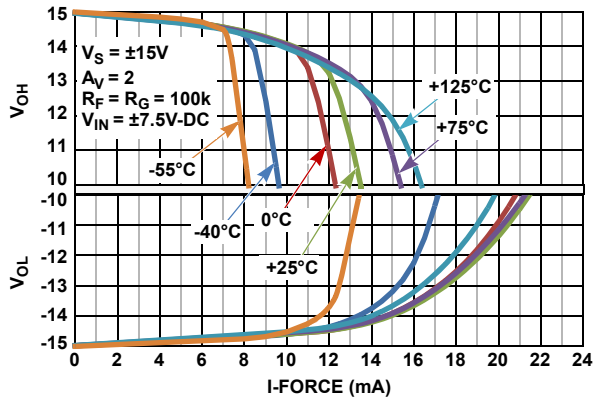

FIGURE 23. OUTPUT VOLTAGE SWING vs LOAD CURRENT, $V_S = \pm 15V$

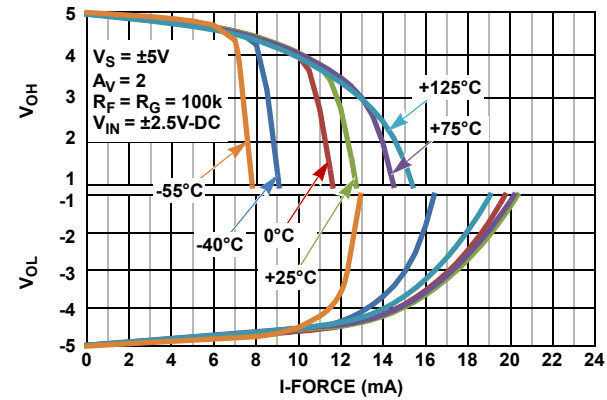

FIGURE 24. OUTPUT VOLTAGE SWING vs LOAD CURRENT, $V_S = \pm 5V$

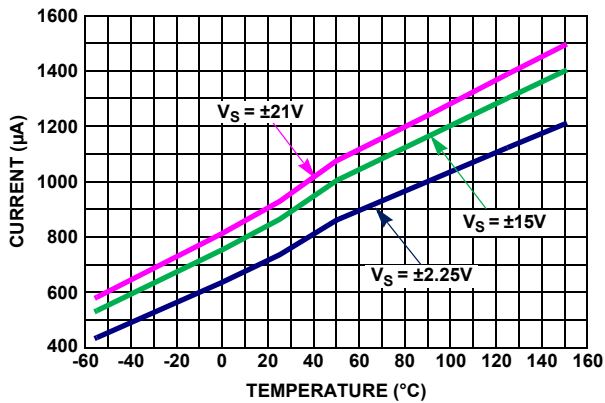

FIGURE 25. SUPPLY CURRENT vs TEMPERATURE vs SUPPLY VOLTAGE

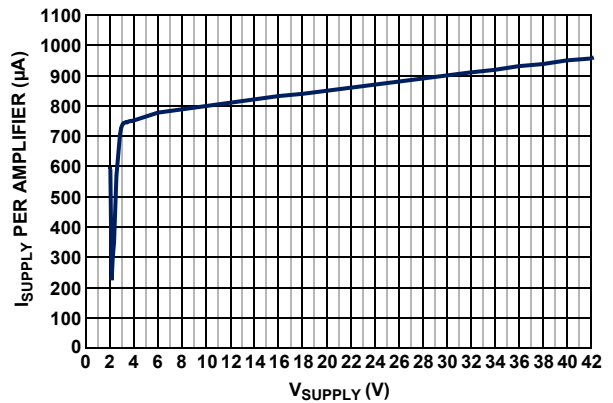

FIGURE 26. SUPPLY CURRENT vs SUPPLY VOLTAGE

Typical Performance Curves $V_S = \pm 15V, V_{CM} = 0V, R_L = \text{Open}, T_A = +25^\circ C$, unless otherwise specified. (Continued)

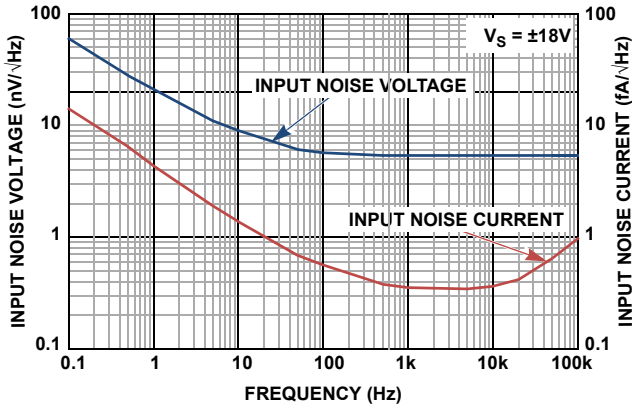

FIGURE 27. INPUT NOISE VOLTAGE (en) AND CURRENT (in) vs FREQUENCY, $V_S = \pm 18V$

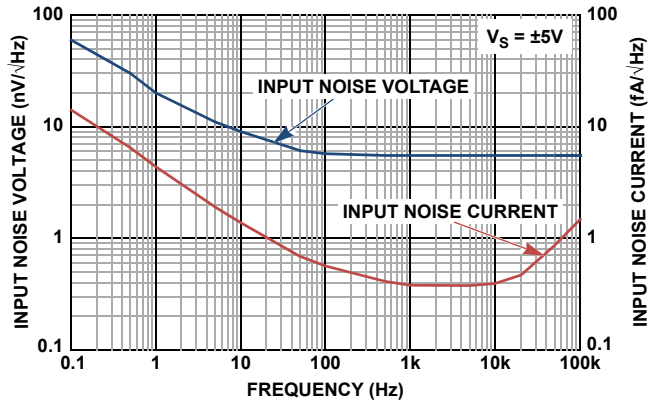

FIGURE 28. INPUT NOISE VOLTAGE (en) AND CURRENT (in) vs FREQUENCY, $V_S = \pm 5V$

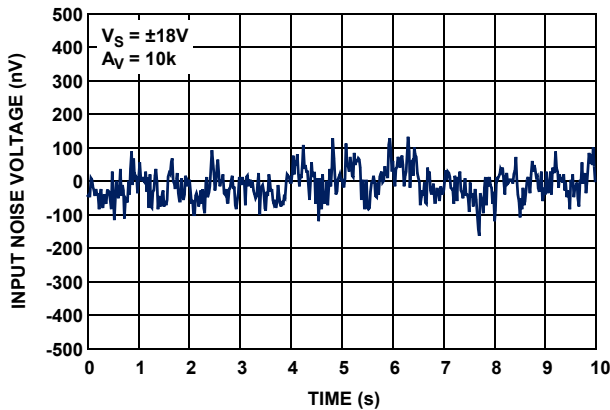

FIGURE 29. INPUT NOISE VOLTAGE 0.1Hz TO 10Hz, $V_S = \pm 18V$

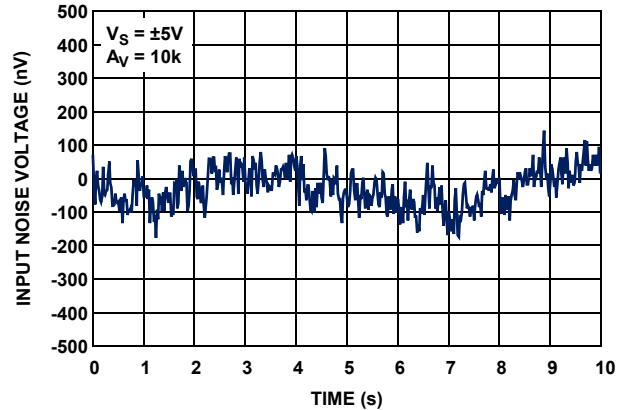

FIGURE 30. INPUT NOISE VOLTAGE 0.1Hz TO 10Hz, $V_S = \pm 5V$

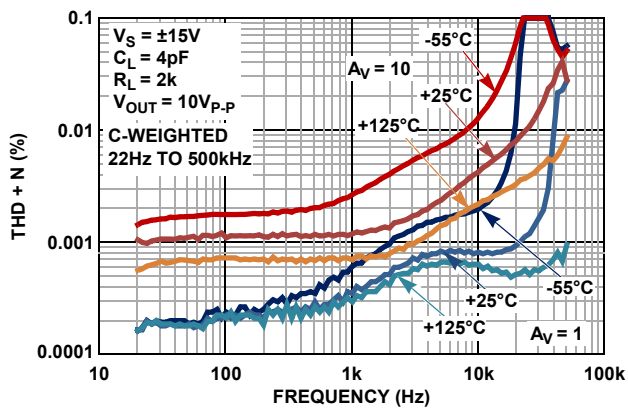

FIGURE 31. THD+N vs FREQUENCY vs TEMPERATURE, $A_V = 1, 10, R_L = 2k$

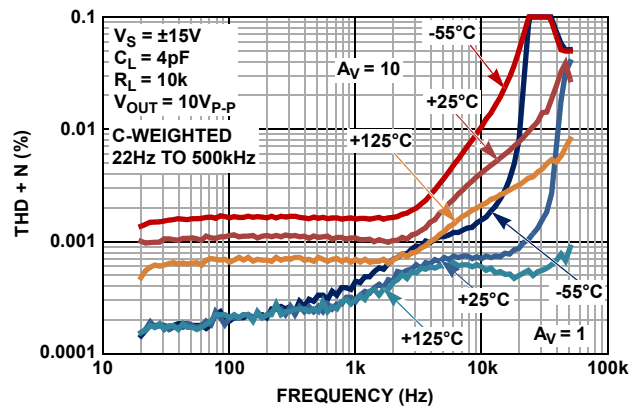

FIGURE 32. THD+N vs FREQUENCY vs TEMPERATURE, $A_V = 1, 10, R_L = 10k$

Typical Performance Curves $V_S = \pm 15V, V_{CM} = 0V, R_L = \text{Open}, T_A = +25^\circ C$, unless otherwise specified. (Continued)

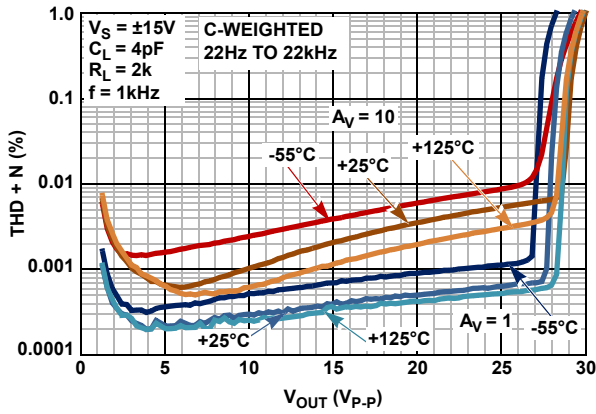

FIGURE 33. THD+N vs OUTPUT VOLTAGE (V_{OUT}) vs TEMPERATURE, $A_V = 1, 10, R_L = 2k$

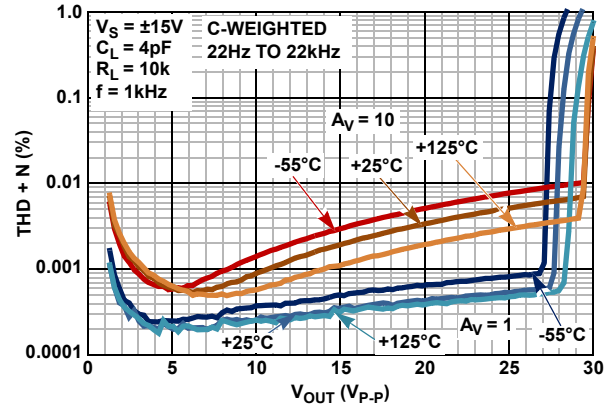

FIGURE 34. THD+N vs OUTPUT VOLTAGE (V_{OUT}) vs TEMPERATURE, $A_V = 1, 10, R_L = 10k$

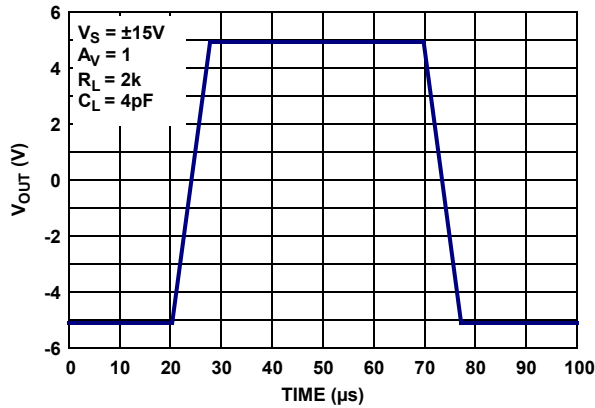

FIGURE 35. LARGE SIGNAL 10V STEP RESPONSE, $V_S = \pm 15V$

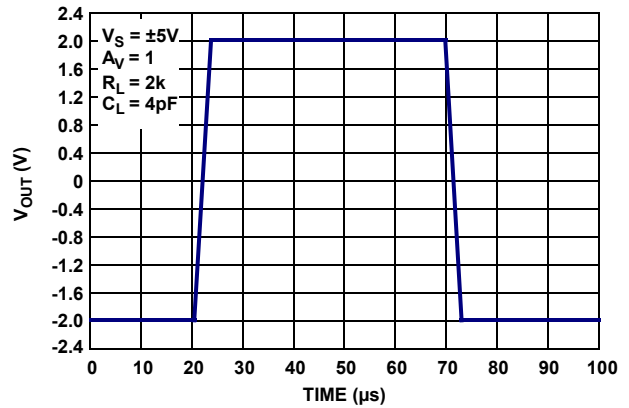

FIGURE 36. LARGE SIGNAL 4V STEP RESPONSE, $V_S = \pm 5V$

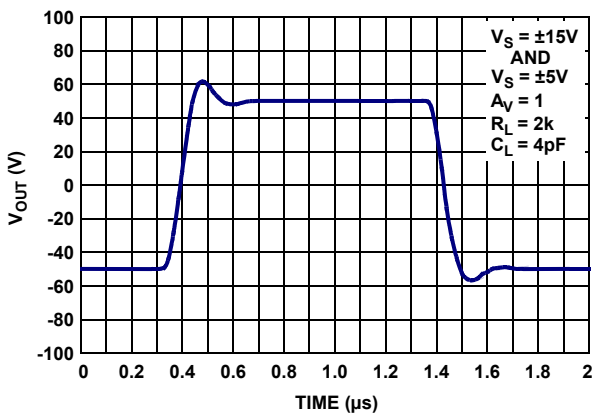

FIGURE 37. SMALL SIGNAL TRANSIENT RESPONSE, $V_S = \pm 5V, \pm 15V$

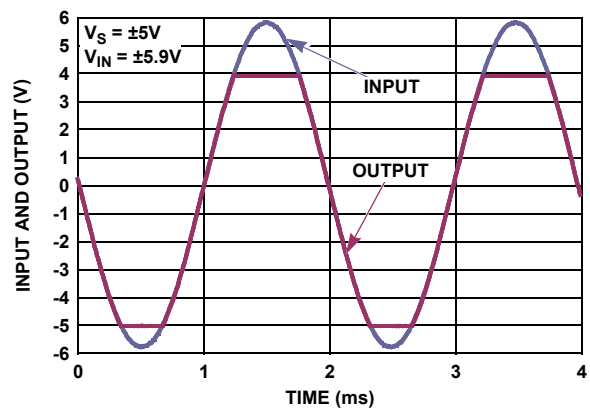

FIGURE 38. NO PHASE REVERSAL

Typical Performance Curves $V_S = \pm 15V, V_{CM} = 0V, R_L = \text{Open}, T_A = +25^\circ C$, unless otherwise specified. (Continued)

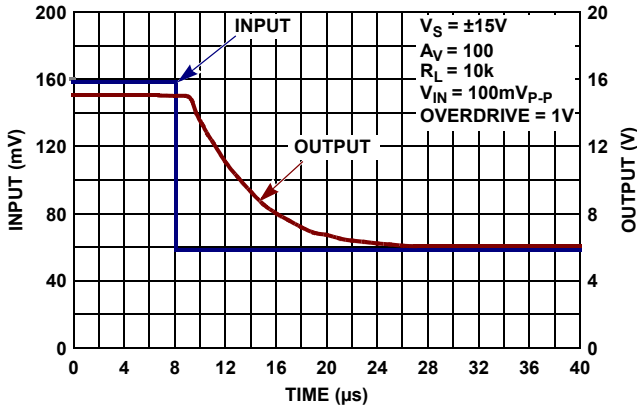

FIGURE 39. POSITIVE OUTPUT OVERLOAD RESPONSE TIME, $V_S = \pm 15V$

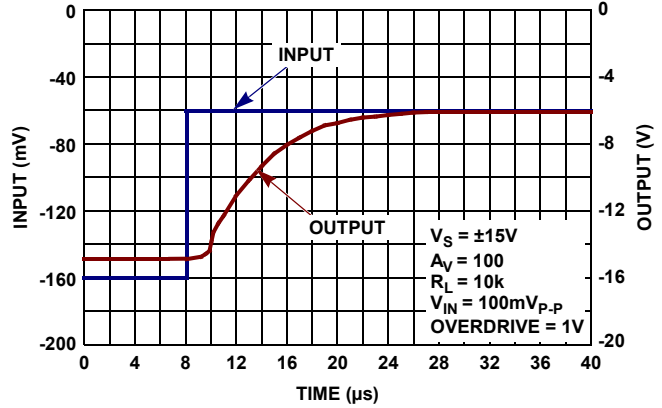

FIGURE 40. NEGATIVE OUTPUT OVERLOAD RESPONSE TIME, $V_S = \pm 15V$

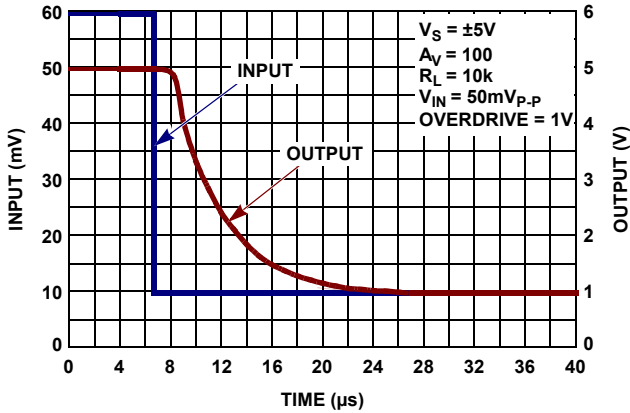

FIGURE 41. POSITIVE OUTPUT OVERLOAD RESPONSE TIME, $V_S = \pm 5V$

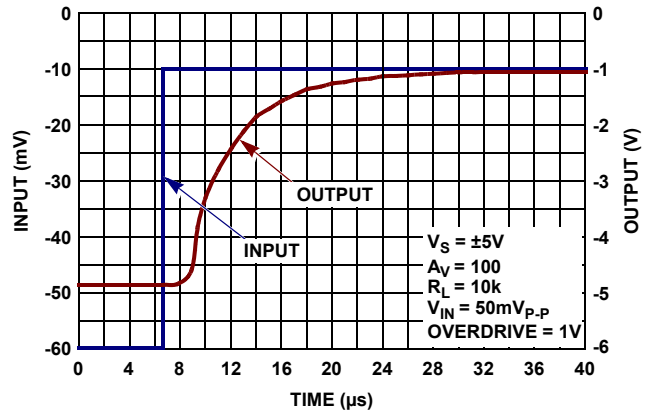

FIGURE 42. NEGATIVE OUTPUT OVERLOAD RESPONSE TIME, $V_S = \pm 5V$

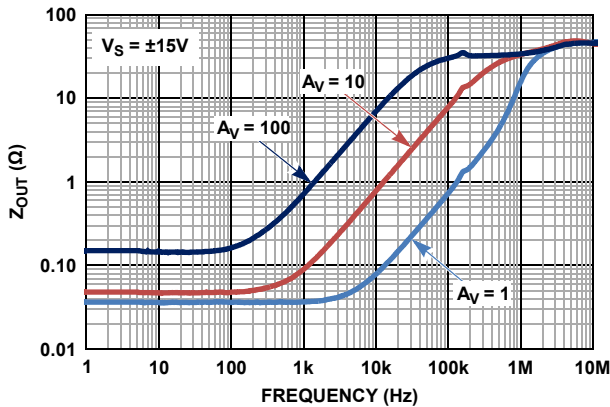

FIGURE 43. OUTPUT IMPEDANCE vs FREQUENCY, $V_S = \pm 15V$

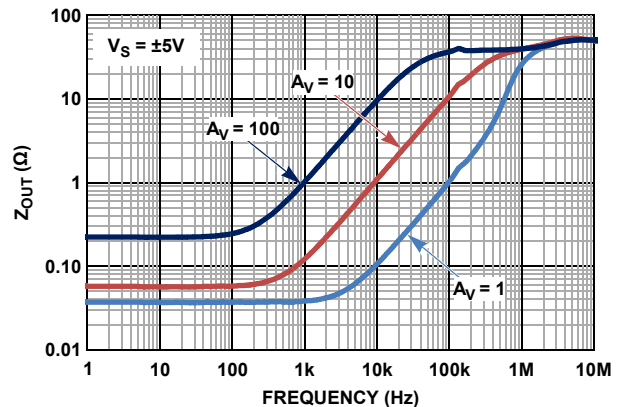

FIGURE 44. OUTPUT IMPEDANCE vs FREQUENCY, $V_S = \pm 5V$

Typical Performance Curves $V_S = \pm 15V, V_{CM} = 0V, R_L = \text{Open}, T_A = +25^\circ C$, unless otherwise specified. (Continued)

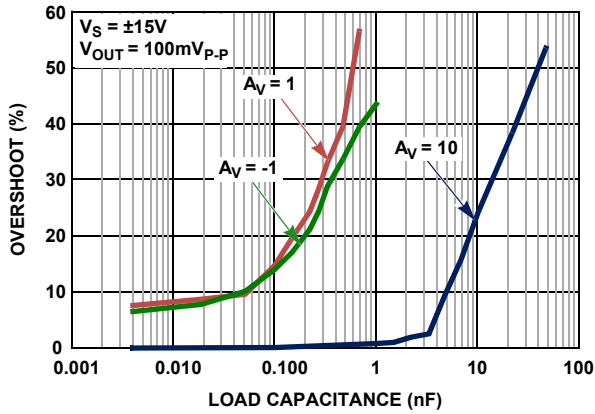

FIGURE 45. OVERSHOOT vs CAPACITIVE LOAD, $V_S = \pm 15V$

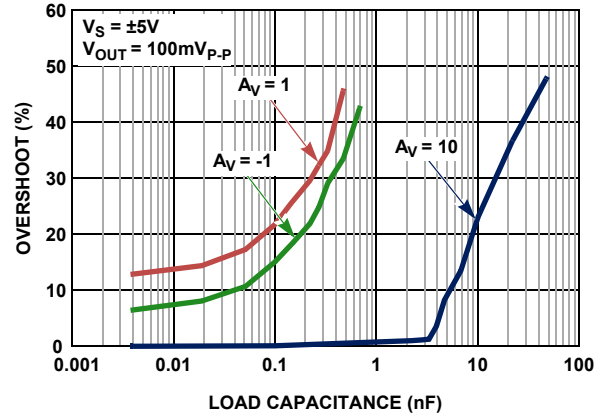

FIGURE 46. OVERSHOOT vs CAPACITIVE LOAD, $V_S = \pm 5V$

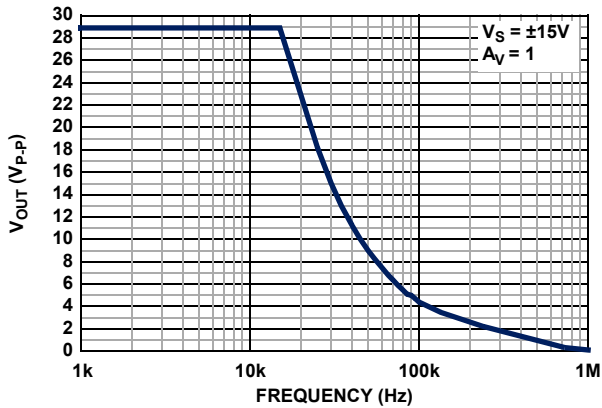

FIGURE 47. IMAX OUTPUT VOLTAGE vs FREQUENCY

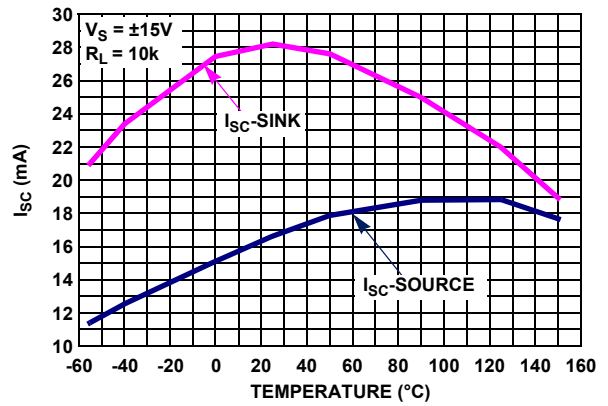

FIGURE 48. SHORT CIRCUIT CURRENT vs TEMPERATURE, $V_S = \pm 15V$

Applications Information

Functional Description

The ISL70218SEH is a dual, 3.2MHz, single or dual supply, rail-to-rail output amplifier with a common mode input voltage range extending to a range of 0.5V below the V- rail. The input stage is optimized for precision sensing of ground-referenced signals in single-supply applications. The input stage is able to handle large input differential voltages without phase inversion, making this amplifier suitable for high-voltage comparator applications. The bipolar design features high open loop gain and excellent DC input and output temperature stability. This op amp features very low quiescent current of 850 μ A, and low temperature drift. The device is fabricated in a new precision 40V complementary bipolar DI process and is immune from latch-up for up to a 36V supply range.

Operating Voltage Range

The op amp is designed to operate over a single supply range of 3V to 36V or a split supply voltage range of +1.8V/-1.2V to \pm 18V. The device is fully characterized at 30V (\pm 15V). Both DC and AC performance remain virtually unchanged over the complete operating voltage range. Parameter variation with operating voltage is shown in the [“Typical Performance Curves”](#) beginning on [page 8](#).

The input common mode voltage to the V+ rail (V+ - 1.8V over the full temperature range) may limit amplifier operation when operating from split V+ and V- supplies. [Figure 4](#) shows the common mode input voltage range variation over temperature.

Input Stage Performance

The ISL70218SEH PNP input stage has a common mode input range extending up to 0.5V below ground at +25 $^{\circ}$ C. Full amplifier performance is guaranteed for input voltage down to ground (V-) across the -55 $^{\circ}$ C to +125 $^{\circ}$ C temperature range. For common mode voltages down to -0.5V below ground (V-), the amplifiers are fully functional, but performance degrades slightly over the full temperature range. This feature provides excellent CMRR, AC performance, and DC accuracy when amplifying low-level, ground-referenced signals.

The input stage has a maximum input differential voltage equal to a diode drop greater than the supply voltage and does not contain the back-to-back input protection diodes found on many similar amplifiers. This feature enables the device to function as a precision comparator by maintaining very high input impedance for high-voltage differential input comparator voltages. The high differential input impedance also enables the device to operate reliably in large signal pulse applications, without the need for anti-parallel clamp diodes required on MOSFET and most bipolar input stage op amps. Thus, input signal distortion caused by nonlinear clamps under high slew rate conditions is avoided.

In applications in which one or both amplifier input terminals are at risk of exposure to voltages beyond the supply rails, current-limiting resistors may be needed at each input terminal (see [Figure 49](#), R_{IN+}, R_{IN-}) to limit current through the power-supply ESD diodes to 20mA.

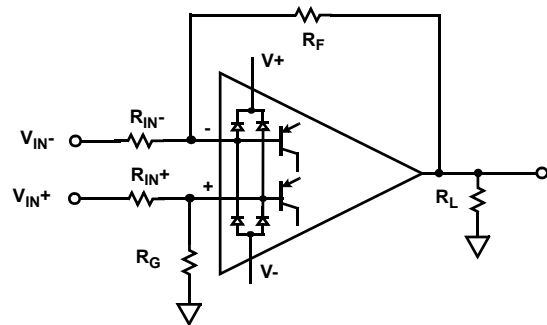

FIGURE 49. INPUT ESD DIODE CURRENT LIMITING

Output Drive Capability

The bipolar rail-to-rail output stage features low saturation levels that enable an output voltage swing to less than 15mV when the total output load (including feedback resistance) is held below 50 μ A ([Figures 21](#) and [22](#)). With \pm 15V supplies, this can be achieved by using feedback resistor values >300k Ω .

The output stage is internally current limited. Output current limit over temperature is shown in [Figures 23](#) and [24](#). The amplifiers can withstand a short circuit to either rail as long as the power dissipation limits are not exceeded. This applies to only one amplifier at a time for the dual op amp. Continuous operation under these conditions may degrade long-term reliability.

The amplifiers perform well when driving capacitive loads ([Figures 45](#) and [46](#)). The unity gain, voltage follower (buffer) configuration provides the highest bandwidth but is also the most sensitive to ringing produced by load capacitance found in BNC cables. Unity gain overshoot is limited to 35% at capacitance values to 0.33nF. At gains of 10 and higher, the device is capable of driving more than 10nF without significant overshoot.

Output Phase Reversal

Output phase reversal is a change of polarity in the amplifier transfer function when the input voltage exceeds the supply voltage. The ISL70218SEH is immune to output phase reversal out to 0.5V beyond the rail (V_{ABS MAX}) limit ([Figure 38](#)).

Single Channel Usage

The ISL70218SEH is a dual op amp. If the application requires only one channel, the user must configure the unused channel to prevent it from oscillating. The unused channel oscillates if the input and output pins are floating. This results in higher-than-expected supply currents and possible noise injection into the channel being used. The proper way to prevent oscillation is to short the output to the inverting input, and ground the positive input ([Figure 50](#)).

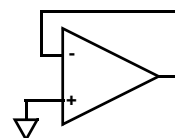

FIGURE 50. PREVENTING OSCILLATIONS IN UNUSED CHANNELS

Power Dissipation

It is possible to exceed the +150°C maximum junction temperatures under certain load and power supply conditions. It is therefore important to calculate the maximum junction temperature (T_{JMAX}) for all applications to determine if power supply voltages, load conditions, or package type need to be modified to remain in the safe operating area. These parameters are related using [Equation 1](#):

$$T_{JMAX} = T_{MAX} + \theta_{JA} \times PD_{MAXTOTAL} \quad (EQ. 1)$$

where

- $PD_{MAXTOTAL}$ is the sum of the maximum power dissipation of each amplifier in the package (PD_{MAX})
- T_{MAX} = Maximum ambient temperature
- θ_{JA} = Thermal resistance of the package

Package Characteristics

Weight of Packaged Device

0. 4029 grams (Typical)

Lid Characteristics

Finish: Gold

Case Isolation to Any Lead: $20 \times 10^9 \Omega$ (min)

Die Characteristics

Die Dimensions

1565 μ m x 2125 μ m (62mils x 84mils)

Thickness: 355 μ m \pm 25 μ m (14 mils \pm 1 mil)

Interface Materials

GLASSIVATION

Type: Nitrox

Thickness: 15kÅ

PD_{MAX} for each amplifier can be calculated using [Equation 2](#):

$$PD_{MAX} = V_S \times I_{qMAX} + (V_S - V_{OUTMAX}) \times \frac{V_{OUTMAX}}{R_L} \quad (EQ. 2)$$

where

- PD_{MAX} = Maximum power dissipation of one amplifier
- V_S = Total supply voltage
- I_{qMAX} = Maximum quiescent supply current of one amplifier
- V_{OUTMAX} = Maximum output voltage swing of the application
- R_L = Load resistance

TOP METALLIZATION

Type: AlCu (99.5%/0.5%)

Thickness: 30kÅ

BACKSIDE FINISH

Silicon

PROCESS

Dielectrically Isolated Complementary Bipolar - PR40

ASSEMBLY RELATED INFORMATION

SUBSTRATE POTENTIAL

Floating

ADDITIONAL INFORMATION

WORST CASE CURRENT DENSITY

$< 2 \times 10^5$ A/cm²

Metallization Mask Layout

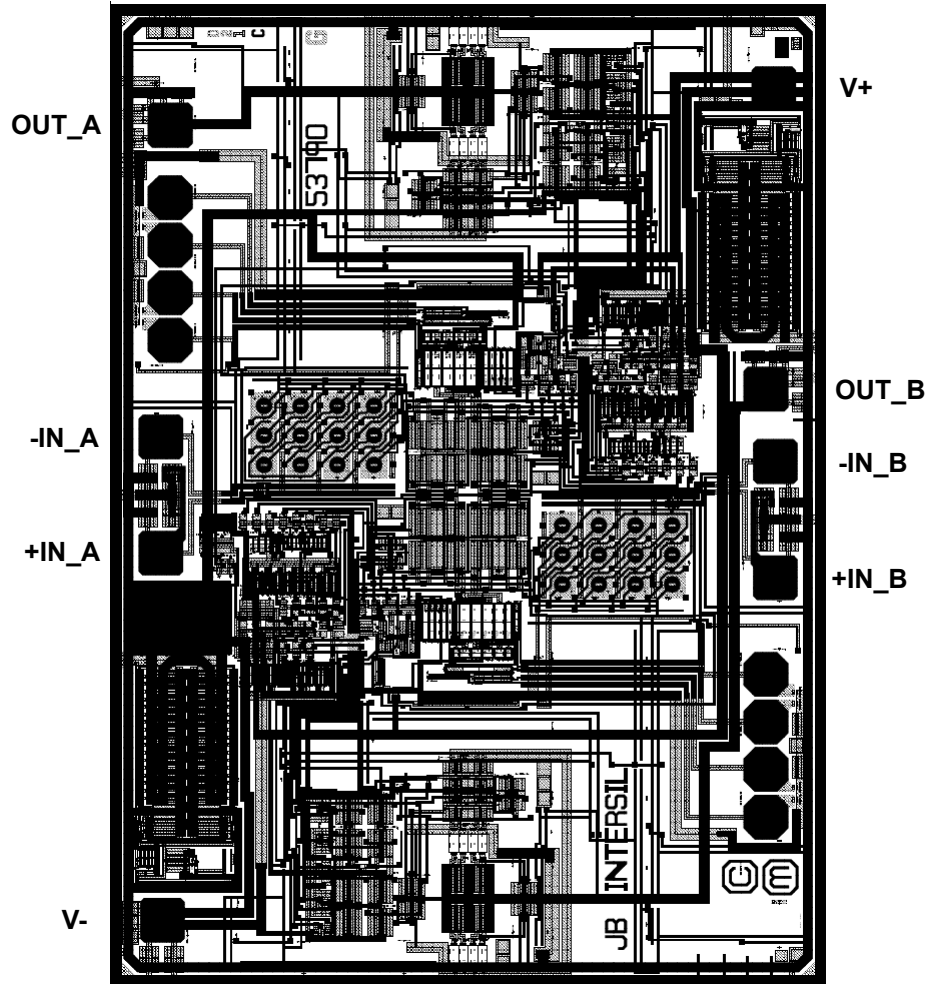

TABLE 1. DIE LAYOUT X-Y COORDINATES

| PAD NAME | PAD NUMBER | X (μm) | Y (μm) | dX (μm) | dY (μm) | BOND WIRES PER PAD |
|----------|------------|--------|--------|---------|---------|--------------------|
| OUT_A | 1 | 16.5 | 1670 | 70 | 70 | 1 |
| -IN_A | 6 | -3 | 1015 | 70 | 70 | 1 |
| +IN_A | 7 | -3 | 771 | 70 | 70 | 1 |
| V- | 8 | 0 | 0 | 70 | 70 | 1 |
| +IN_B | 12 | 1287 | 719.5 | 70 | 70 | 1 |
| -IN_B | 11 | 1287 | 963.5 | 70 | 70 | 1 |
| OUT_B | 10 | 1267.5 | 1115.5 | 70 | 70 | 1 |
| V+ | 9 | 1284 | 1746.5 | 70 | 70 | 1 |

NOTE:

6. Origin of coordinates is the centroid of pad 8.

Revision History

The revision history provided is for informational purposes only and is believed to be accurate, but not warranted. Please go to web to make sure you have the latest revision.

| DATE | REVISION | CHANGE |
|-------------------|----------|--|
| July 24, 2014 | FN7957.2 | <p>Updated Features on page 1, Radiation Tolerance bullet as follows: from</p> <ul style="list-style-type: none"> • Radiation Tolerance <ul style="list-style-type: none"> - SEL/SEB LET_{TH} (V_S = ±18V) 86.4 MeV*cm²/mg - High Dose Rate 100krad(Si) - Low Dose Rate 100krad(Si) <p>to</p> <ul style="list-style-type: none"> • Radiation tolerance <ul style="list-style-type: none"> - High dose rate (50-300rad(Si)/s) 100krad(Si) - Low dose rate (0.01rad(Si)/s) 100krad(Si)* - SEB LET_{TH} (V_S = ±18V) 86.4 MeV*cm²/mg - SEL Immune (SOI Process) <p>Updated the Ordering Information table on page 2 as follows:</p> <ul style="list-style-type: none"> - Removed MSL note. - Added SMD ordering note. <p>Replaced the Products verbiage with the About Intersil Verbiage on page 19.</p> |
| August 24, 2012 | FN7957.1 | <ol style="list-style-type: none"> 1. Electrical Specification tables (pages 3-6), added specs on overshoot and rise/fall times. 2. Page 3 - Added Abs Max in a non radiation environment <p>Changed ESD HBM from 3kV to 2kV Changed ESD CDM from 2kV to 750V</p> |
| February 16, 2012 | FN7957.0 | Initial Release |

About Intersil

Intersil Corporation is a leading provider of innovative power management and precision analog solutions. The company's products address some of the largest markets within the industrial and infrastructure, mobile computing and high-end consumer markets.

For the most updated datasheet, application notes, related documentation and related parts, please see the respective product information page found at www.intersil.com.

You may report errors or suggestions for improving this datasheet by visiting www.intersil.com/ask.

Reliability reports are also available from our website at www.intersil.com/support

For additional products, see www.intersil.com/en/products.html

Intersil products are manufactured, assembled and tested utilizing ISO9001 quality systems as noted in the quality certifications found at www.intersil.com/en/support/qualandreliability.html

Intersil products are sold by description only. Intersil Corporation reserves the right to make changes in circuit design, software and/or specifications at any time without notice. Accordingly, the reader is cautioned to verify that data sheets are current before placing orders. Information furnished by Intersil is believed to be accurate and reliable. However, no responsibility is assumed by Intersil or its subsidiaries for its use; nor for any infringements of patents or other rights of third parties which may result from its use. No license is granted by implication or otherwise under any patent or patent rights of Intersil or its subsidiaries.

For information regarding Intersil Corporation and its products, see www.intersil.com

Ceramic Metal Seal Flatpack Packages (Flatpack)

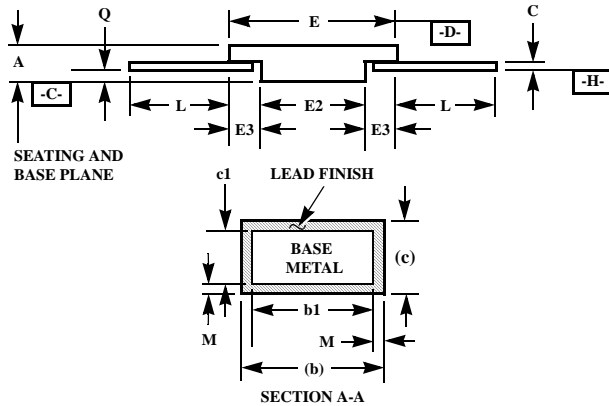
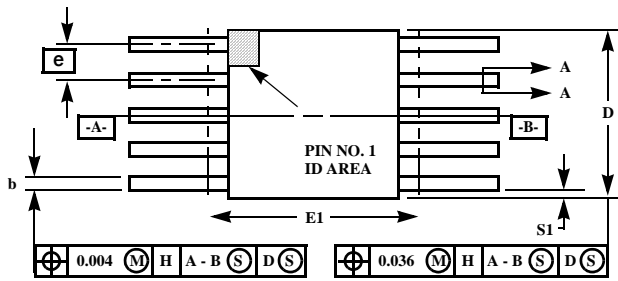

K10.A MIL-STD-1835 CDFP3-F10 (F-4A, CONFIGURATION B) 10 LEAD CERAMIC METAL SEAL FLATPACK PACKAGE

| SYMBOL | INCHES | | MILLIMETERS | | NOTES |
|--------|-----------|--------|-------------|------|-------|
| | MIN | MAX | MIN | MAX | |
| A | 0.045 | 0.115 | 1.14 | 2.92 | - |
| b | 0.015 | 0.022 | 0.38 | 0.56 | - |
| b1 | 0.015 | 0.019 | 0.38 | 0.48 | - |
| c | 0.004 | 0.009 | 0.10 | 0.23 | - |
| c1 | 0.004 | 0.006 | 0.10 | 0.15 | - |
| D | - | 0.290 | - | 7.37 | 3 |
| E | 0.240 | 0.260 | 6.10 | 6.60 | - |
| E1 | - | 0.280 | - | 7.11 | 3 |
| E2 | 0.125 | - | 3.18 | - | - |
| E3 | 0.030 | - | 0.76 | - | 7 |
| e | 0.050 BSC | | 1.27 BSC | | - |
| k | 0.008 | 0.015 | 0.20 | 0.38 | 2 |
| L | 0.250 | 0.370 | 6.35 | 9.40 | - |
| Q | 0.026 | 0.045 | 0.66 | 1.14 | 8 |
| S1 | 0.005 | - | 0.13 | - | 6 |
| M | - | 0.0015 | - | 0.04 | - |
| N | 10 | | 10 | | - |

Rev. 0 3/07

NOTES:

1. Index area: A notch or a pin one identification mark shall be located adjacent to pin one and shall be located within the shaded area shown. The manufacturer's identification shall not be used as a pin one identification mark. Alternately, a tab (dimension k) may be used to identify pin one.
2. If a pin one identification mark is used in addition to a tab, the limits of dimension k do not apply.
3. This dimension allows for off-center lid, meniscus, and glass overrun.
4. Dimensions b1 and c1 apply to lead base metal only. Dimension M applies to lead plating and finish thickness. The maximum limits of lead dimensions b and c or M shall be measured at the centroid of the finished lead surfaces, when solder dip or tin plate lead finish is applied.
5. N is the maximum number of terminal positions.
6. Measure dimension S1 at all four corners.
7. For bottom-brazed lead packages, no organic or polymeric materials shall be molded to the bottom of the package to cover the leads.
8. Dimension Q shall be measured at the point of exit (beyond the meniscus) of the lead from the body. Dimension Q minimum shall be reduced by 0.0015 inch (0.038mm) maximum when solder dip lead finish is applied.
9. Dimensioning and tolerancing per ANSI Y14.5M - 1982.
10. Controlling dimension: INCH.